

## Product Data Sheet

- ✧ KL05613WDBA/BY
- ✧ Digit height: 0.56 inch (14.20mm)
- ✧ Digit number: 1 digit
- ✧ Emitting color: Yellow

### **Dongguan Kinley Industrial Co., Ltd**

**Add:** Humen 3<sup>rd</sup> Industrial District, Humen Town Dongguan City GD,CN

**Tel:** 0086 135 3866 1622

**Email:** sales@dgkinley.com

**Web:** [www.dgkinley.com](http://www.dgkinley.com)

# Dongguan Kinley Industrial Co., Ltd

## Selection Guide

Part No.	Emitting color	Wavelength	Lens color	Intensity	Polarity	Surface color
KL05613WDBAY	Yellow	585-595nm	White diffused	80-90mcd	Common cathode	Black
KL05613WDBBY	Yellow	585-595nm	White diffused	80-90mcd	Common anode	Black
KL05613WDGAY	Yellow	585-595nm	White diffused	80-90mcd	Common cathode	Gray
KL05613WDGBY	Yellow	585-595nm	White diffused	80-90mcd	Common anode	Gray



# Dongguan Kinley Industrial Co., Ltd

## Dimension and Diagram

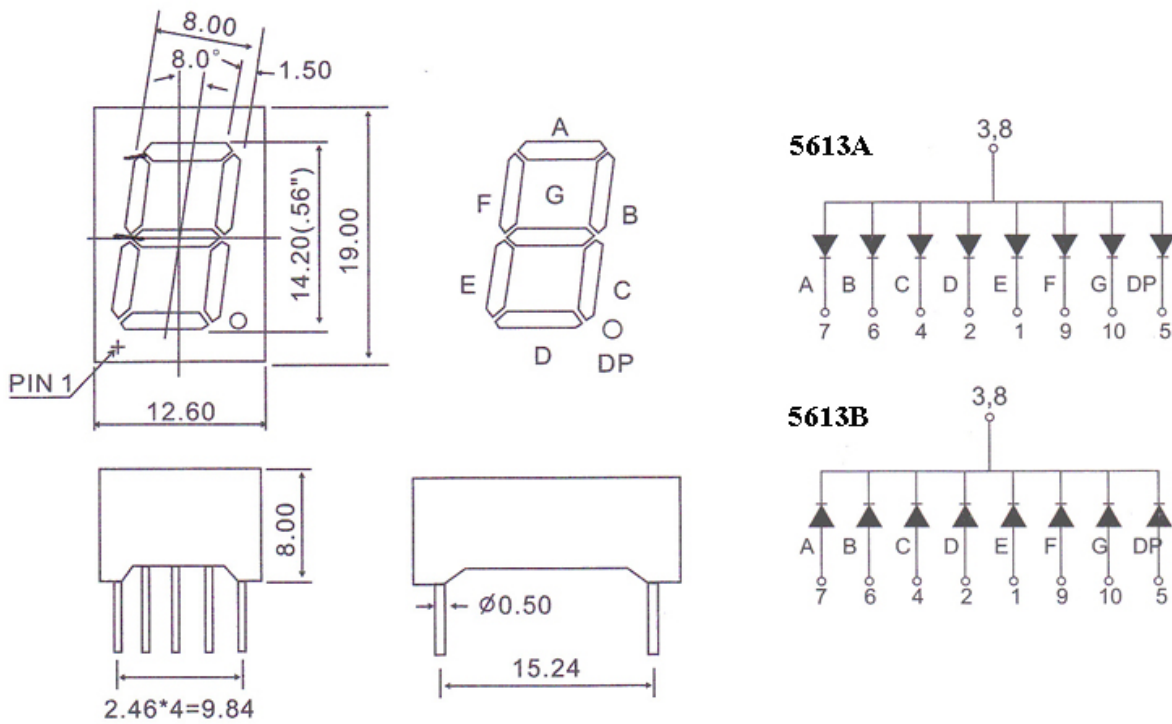

Notes:

1. Dimension in millimeter [inch], tolerance is  $\pm 0.25$  [.010] and angle is  $\pm 1^\circ$  unless otherwise noted.
2. Bending  $\leq$  Length \* 1%.
3. The specifications characteristics and technical data described in the datasheet are subject to change without prior notice.

# Dongguan Kinley Industrial Co., Ltd

## Absolute Maximum Ratings at TA=25°C

Parameter	Symbol	Test Condition	Value		Unit
			Min	Max	
Reverse Voltage	VR	IR=30	5	—	V
Forward Current	IF	—	—	10	mA
Power Dissipation	Pd	—	—	100	mW
Pulse Current	Ipeak	Duty=0.1mS,1KHz	—	150	mA
Operating Temperature	T opr	—	-40	+85	°C
Storage Temperature	T str	—	-40	+85	°C

## Electro-Optical Characteristics (Ta=25°C)

Parameter		Symbol	Min.	Typ.	Max.	Units	Condition
Forward Voltage		V <sub>F</sub>	--	1.9	2.1	V	I <sub>F</sub> =10mA
Reverse Current		I <sub>R</sub>	--	--	10	μA	V <sub>R</sub> =5V
Luminous Intensity	Per segment	I <sub>V</sub>	80	85	90	mcd	I <sub>F</sub> =10mA
	Per decimal point		80	85	90		
Peak Wavelength		λ <sub>p</sub>	--	595	--	nm	I <sub>F</sub> =10mA
Dominant Wavelength		λ <sub>d</sub>	--	590	--	nm	I <sub>F</sub> =10mA
Spectrum Radiation Bandwidth		Δλ	--	20	--	nm	I <sub>F</sub> =10mA

Note:

1.Luminous Intensity is based on the Kinley standards.

2.Pay attention about Intensity is only for one chip

# Dongguan Kinley Industrial Co., Ltd

## Reliability test items and conditions:

The reliability of products shall be satisfied with items listed below. Confidence level:90% LTPD:10%

NO	Item	Test Conditions	Test Hours/Cycle	Sample Size	Failure Judgment Criteria	Ac/Re
1	Reflow Soldering	TEMP:230°C±5°C Min. 5 SEC	6 Min	22 PCS	$I_v \leq I_{vt} * 0.5$ or $V_F \geq U$ or $V_F \leq L$	0/1
2	Temperature Cycle	H:+100°C 15min ∫ 5min L:-40°C 15min	300 Cycles	22 PCS		0/1
3	Thermal Shock	H:+100°C 5min ∫ 10 sec L:-10°C 5min	300 Cycles	22 PCS		0/1
4	High Temperature Storage	TEMP:100°C	1000 HRS	22PCS		0/1
5	Low Temperature Storage	TEMP:-40°C	1000 HRS	22 PCS		0/1
6	DC Operating Life	TEMP:25°C If=10mA	1000 HRS	22 PCS		0/1
7	High Temperature / High Humidity	85°C / 85% RH	1000 HRS	22 PCS		0/1

Note:

Ivt: The test I<sub>v</sub> value of the chip before the reliability test

I<sub>v</sub>: The test value of the chip that has completed the reliability test

U: Upper Specification Limit L: Lower Specification Limit

# Dongguan Kinley Industrial Co., Ltd

Reflow Temp. / Time :



## ■ Soldering Iron :

Basic spec is  $\leq 5$  sec when 230°C. If temperature is higher, time should be shorter (+10°C → -1sec).

Power dissipation of iron should be smaller than 15 W, and temperature should be controllable. Surface temperature of the device should be under 230 °C.

## ■ Rework :

1. Customer must finish rework within 5 sec under 230°C.
2. The head of iron can not touch copper foil.